

USER MANUAL

CITIZEN □ Colour Television

C24404

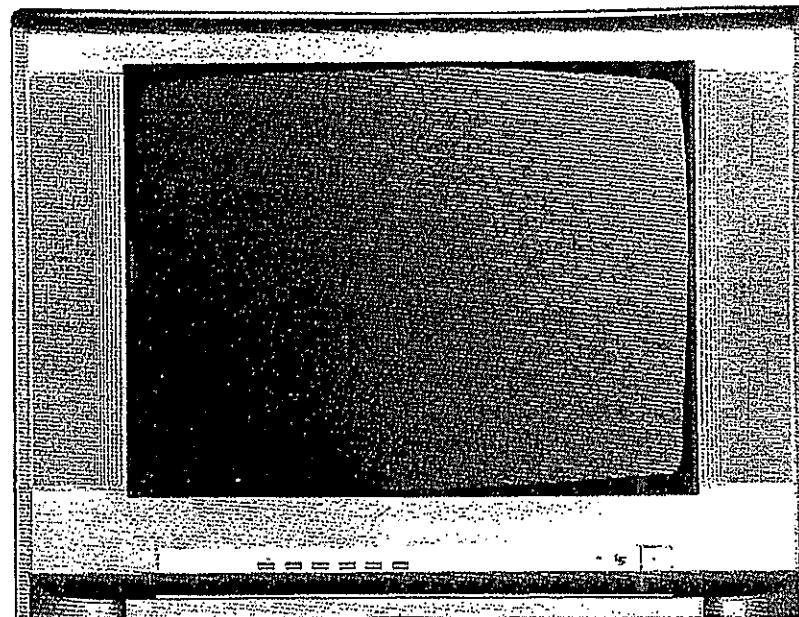

**Before operating this product,
please read these instructions carefully.**

SPECIFICATIONS

Television System:	NTSC
Receiving channel:	181 channel tuner (Frequency synthesized tuning)
Audio output:	2 speakers of 3W each
Audio output mode:	RF-MONO, A/V STEREO
Antenna impedance:	75 ohms terminal
Output terminal:	Video input 1vp-p/75 OH, audio input 400mV
Closed caption:	NTSC/M receiving time (cc1-cc4/tt1-tt4)
OSD Language:	English/French/Spanish
Power:	AC 90-130V, 50/60 Hz
Measurements (Length Width Height):	20" – 645 x 505 x 510 (mm) 24" – 735 x 515 x 595 (mm) 27" – 845 x 568 x 640 (mm)

Net Weight:	20" – 23 kg, 24" – 29 kg and 27" – 39 kg
Accessories:	one remote control one instruction manual

Design and specifications are subject to change without prior notice

THE CAUSES OF INTERFERENCE

Incorporated in your TV set is the most up-to-date technology to eliminate interference. Local radiation however, can create disturbances which in turn, can noticeably affect the picture. Proper installation and a good antenna are your best safeguards against these disturbances.

INTERFERENCE

Moving ripples across the screen are caused by nearby transmitting or receiving shortwave radio equipment.

DIATHERMY

Herringbone pattern and partial picture loss can result from the operation of diathermy equipment from a nearby medical center or hospital.

SNOW

Weak TV signals from long distant stations result in an unsteady picture and give the effect of falling snow. An antenna adjustment or antenna amplifier may be needed.

GHOST

Multiple images caused by TV signals reflected back from surrounding buildings, hills, aircraft, etc. are minimized by proper antenna positioning.

CAR IGNITION

Nearby cars and electrical motors can cause small streaks across the picture or make the picture roll.

INTRODUCTION

Thank you very much for purchasing our product. To ensure that you can fully understand the capabilities of this television set, read this entire manual carefully, and keep it handy for future reference.

INSTALLATION

- Locate the TV set in a room where direct light does not reflect on the screen. Total darkness or a reflection on the picture screen can cause eye strain. Soft and indirect lighting is recommended for comfortable viewing.
- Allow enough space between the TV set and the wall to permit ventilation. Avoid excessively warm locations to prevent possible damage to the cabinet or premature component failure.
- Never connect this TV set to DC supply or any other power supply than the one indicated in SPECIFICATIONS section.
- Do not install the TV set in a location near heat sources such as a radiator, air ducts, direct sunlight or in a closed area without proper ventilation.
- Do not cover the ventilation openings when using the TV set.

CAUTION

Never tamper with any components inside the set or adjust any controls other than those mentioned in this manual. All television receivers are high voltage instruments and the tube is manufactured using a vacuum process. If the tube is broken, glass fragments will be violently expelled. Scratching or chipping of the tube is dangerous and should be avoided. When cleaning the television ensure the set is unplugged and use only a dry soft cloth to remove the dust. During a thunder storm unplug both the power cord and aerial plug to protect the set from damage. Only a qualified technician should attempt any adjustments or repairs inside the television.

IMPORTANT SAFEGUARDS

WARNING: TO PREVENT FIRE OR SHOCK HAZARD, DO NOT EXPOSE THIS APPLIANCE TO RAIN OR MOISTURE.

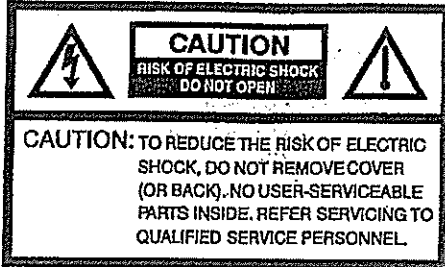

The lightning flash with arrowhead symbol, within an equilateral triangle is intended to alert the user to the presence of uninsulated dangerous voltage within the product's enclosure that may be of sufficient magnitude to constitute a risk of electric shock.



The exclamation point within an equilateral triangle is intended to alert the user to the presence of important operating and maintenance (servicing) instructions in the literature accompanying the appliance.

IMPORTANT SAFEGUARDS

1. READ INSTRUCTIONS

All the safety and operating instructions should be read before the unit is operated.

2. RETAIN INSTRUCTIONS

The safety and operating instructions should be retained for future reference.

3. HEED WARNINGS

All warnings on the unit and in the operating instructions should be adhered to.

4. FOLLOW INSTRUCTIONS

All operating and use instructions should be followed.

5. CLEANING

Unplug this unit from the wall outlet before cleaning. Do not use liquid cleaners or aerosol cleaners.

6. ATTACHMENTS

The manufacturer of this unit does not make any recommendations for attachments, as they may cause hazards.

7. WATER AND MOISTURE

Do not use this unit near water. For example, near a bathtub, washbowl, kitchen sink, laundry tub, in a wet basement, or near a swimming pool.

8. ACCESSORIES

Do not place this unit on an unstable cart, stand, tripod, bracket, or table. The unit may fall, causing serious injury, and serious damage to the unit.

8A. An appliance and cart combination should be moved with care. Quick stops, excessive force, and uneven surfaces may cause the appliance and cart combination to overturn.



9. VENTILATION

Slots and openings in the cabinet back or bottom are provided for ventilation, and to ensure reliable operation of the unit, and to protect it from overheating. These openings must not be blocked or covered. The openings should never be blocked by placing the unit on a bed, sofa, rug, or other similar surface. This unit should never be placed near or over a radiator or heat source. This unit should not be placed in a built-in installation such as a bookcase or rack unless proper ventilation is provided or the manufacturer's instructions have been adhered to.

10. POWER SOURCE

This unit should be operated only from the type of power source indicated on the rating plate. If you are not sure of the type of power supply to your home, consult your appliance dealer or local power company. For units intended to operate from battery power, or other sources, refer to the respective pages in this Owner's Manual for their operating instructions.

IMPORTANT SAFEGUARDS (continued)

11. GROUNDING OR POLARIZATION

This unit is equipped with a polarized alternating current line plug (plug having one blade wider than the other). This plug will fit into the power outlet only one way. This is a safety feature. If you are unable to insert the plug fully into the outlet, try reversing the plug. If the plug should still fail to fit, contact your electrician to replace your obsolete outlet. Instead of the polarized alternating-current line plug, your unit may be equipped with a 3-wire grounding-type plug (a plug having a third grounding pin). This plug will only fit into a grounding-type power outlet. This too, is a safety feature. If you are unable to insert the plug into the outlet, contact your electrician to replace your obsolete outlet. Do not defeat the safety purpose of the grounding-type plug.

12. POWER-CORD PROTECTION

Power-supply cords should be routed so that they are not likely to be walked on or pinched by items placed upon or against them, paying particular attention to cords at plugs, convenience receptacles, and the point where they exit from the appliance.

13. LIGHTNING

To protect your unit from a lightning storm, or when it is left unattended and unused for long periods of time, unplug it from the wall outlet and disconnect the antenna or cable system. This will prevent damage to the unit due to lightning and power line surges.

14. POWER LINES

An outside antenna system should not be located in the vicinity of overhead power lines or other electric light or power circuits, or where it can fall onto or against such power lines or circuits. When installing an outside antenna system, extreme care should be taken to keep from touching such power lines or circuits, as contact with them might be fatal.

15. OVERLOADING

Do not overload wall outlets and extension cords, as this can result in a risk of fire or electric shock.

16. OBJECT AND LIQUID ENTRY

Do not push objects through any openings in this unit, as they may touch dangerous voltage points or short out parts that could result in fire or electric shock. Never spill or spray any type of liquid into the unit.

17. OUTDOOR ANTENNA GROUNDING

If an outside antenna or cable system is connected to the unit, be sure the antenna or cable system is grounded to provide some protection against voltage surges and built-up static charges. Section 8 10 of the National Electrical Code (NEC), ANSI/NFPA 70, provides information with respect to proper grounding of the mast and supporting structure, grounding of the lead-in wire to an antenna discharge unit, size of grounding conductors, location of antenna discharge unit, connection to grounding electrodes, and requirements for the grounding electrode. See figure below.

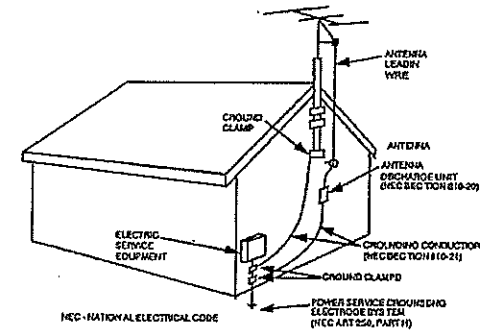

52858A

EXAMPLE OF ANTENNA GROUNDING AS PER NATIONAL ELECTRICAL CODE

IMPORTANT SAFEGUARDS (continued)

18. SERVICING

Do not attempt to service this unit yourself as opening or removing covers may expose you to dangerous voltage or other hazards. Refer all servicing to qualified service personnel.

19. DAMAGE REQUIRING SERVICE

Unplug this unit from the wall outlet and refer servicing to qualified service personnel under the following conditions:

- a. When the power-supply cord or plug is damaged.
- b. If liquid has been spilled, or objects have fallen into the unit.
- c. If the unit has been exposed to rain or water.
- d. If the unit does not operate normally by following the operating instructions. Adjust only those controls that are covered by the operating instructions, as an improper adjustment of other controls may result in damage and will often require extensive work by a qualified technician to restore the unit to its normal operation.
- e. If the unit has been dropped or the cabinet has been damaged.
- f. When the unit exhibits a distinct change in performance, this indicates a need for service.

20. REPLACEMENT PARTS

When replacement parts are required, be sure the service technician uses replacement parts specified by the manufacturer or those that have the same characteristics as the original part. Unauthorized substitutions may result in fire, electric shock or other hazards.

21. SAFETY CHECK

Upon completion of any service or repairs to this unit, ask the service technician to perform safety checks to determine that the unit is in proper operating condition.

22. HEAT

The product should be situated away from heat sources such as radiators, heat registers, stoves, or other products (including amplifiers) that produce heat.

23. CONNECTING

When you connect the product to other equipment, turn off the power and unplug all of the equipment from the wall outlet. Failure to do so may cause an electric shock and serious personal injury. Read the owner's manual of the other equipment carefully and follow the instructions when making any connections.

24. NOTE TO CABLE TV SYSTEM INSTALLER

This reminder is provided to call the Cable TV system installer's attention to Article 820-40 of the NEC that provides guidelines for proper grounding and, in particular, specifies that the cable ground shall be connected to the grounding system of the building, as close to the point of cable entry as practical.

25. DISCONNECTING

To disconnect the main POWER, you must unplug the power cord from the AC outlet.

LOCATION OF CONTROLS

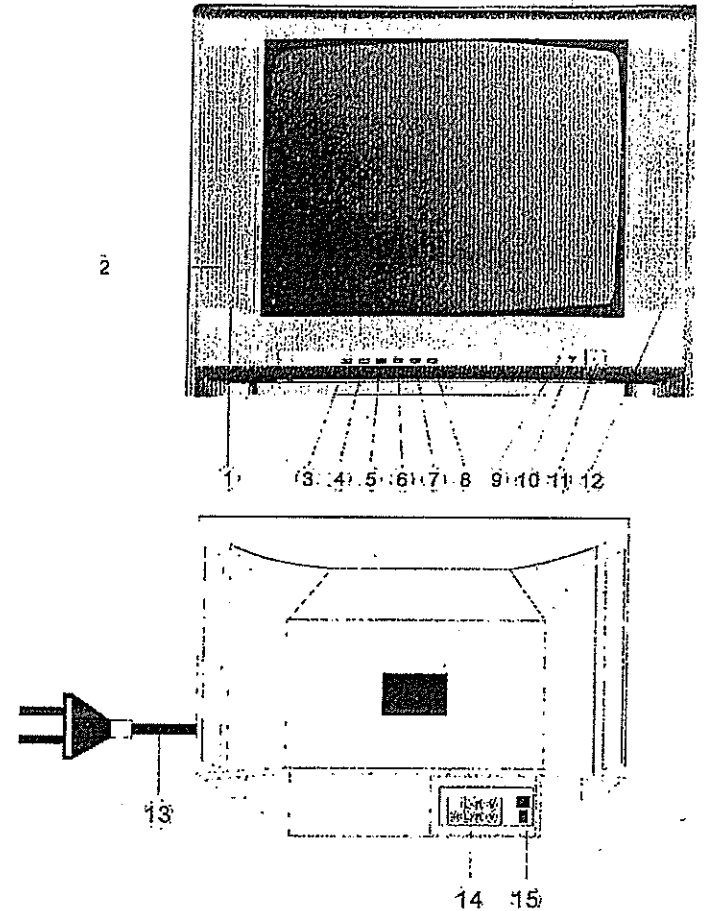

- | | |
|------------------------|--|
| 1. Speaker | 9. Power Indicator |
| 2. Side A/V Inputs | 10. Remote Sensor |
| 3. TV/AV Selector | 11. Standby/ON button |
| 4. Menu Button | 12. Speaker |
| 5. Volume Down Button | 13. AC power Cord |
| 6. Volume Up Button | 14. Audio/Video-input and output jacks |
| 7. Channel Down Button | 15. Antenna terminal (75 ohms) |
| 8. Channel Up Button | |

CONNECTION TO OTHER EQUIPMENT

Connection to other equipment

This TV set can be connected to a VCR, a DVD player, a video camera, a game player or an audio player.

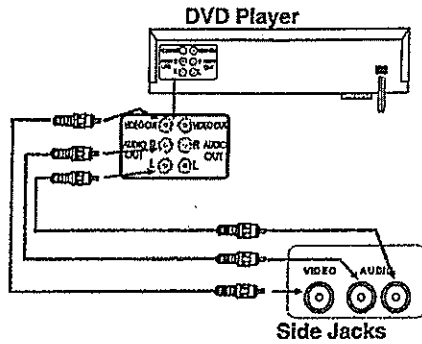

Video/Audio equipment can be connected to AUDIO IN or VIDEO IN jacks located on the back or side panel of the TV set.

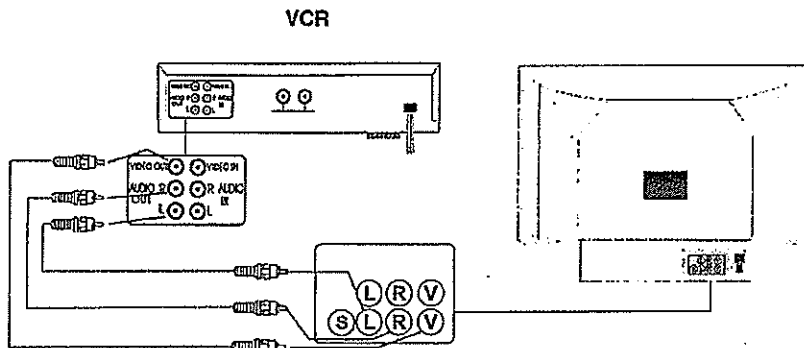

AUTOMATIC CHANNEL PRESET

Press the MENU button so the main menu appears on the screen. Using the CH+/CH- buttons, make the arrow point to "Automatic Search" option and then press either VOL+ or VOL- button to confirm its selection. The TV tuner starts searching for all available channels in your area to memorize them automatically.

Once search completed, the TV is ready for watching.

If you want to set the channels by yourself, please refer to operation instructions in page 12 of this manual.

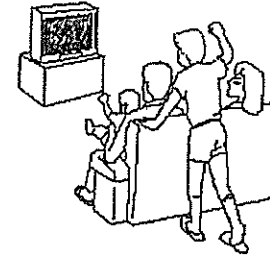

OPERATION

PREPARATION

Once the TV set has been put in place, plug the AC cord into a conveniently located power outlet and then connect the antenna or CATV cable into the antenna plug on the back panel of the TV set. Press the Standby/ON button on the TV set to turn the unit on. When you have picture and sound, press CH+ or CH- button to tune a channel and use the VOL+/VOL- buttons to adjust volume to the proper level. If a blue screen appears, press MENU button on the remote control so the main menu appears on the screen. Use the CH+/CH- buttons to point the arrow to the "Automatic Search" option and then press VOL+ or VOL- button to start channel searching by the tuner. This TV set can memorize channel numbers from 1 to 180. Once the searching is completed, the TV tuner comes back to channel 2.

TO TURN THE TV SET ON AND OFF

- When the TV is plugged into an AC outlet, the main POWER is ON and the TV is in Standby/ON mode.
- The TV set can be put in stand-by mode (OFF) or ON from the remote control by pressing the POWER (or Stand-By) button.
- Please unplug the AC cord when you may not use the unit for an extended period of time.

CAUTION:

If a power failure occurs or the TV is not in use for an extended period of time, disconnect it from the AC outlet.

OPERATION

Main Menu

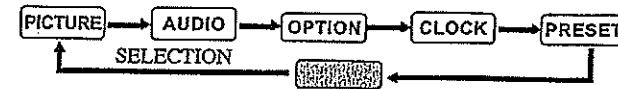

When the TV set is in AV input mode, channel selection cannot be performed.

PICTURE SETTING

1. Press the MENU button once to access the PICTURE menu on the screen. Using the CH+/CH- buttons, select an item from the options listed.
2. Use the VOL+/VOL- buttons to adjust the selected item to the proper setting.
3. The unit automatically memorizes the setting of each item.
4. The TV set will exit the Picture setting mode if no instruction is received within a 10-second period.

PICTURE	
Bright	100
Contrast	100
Color	50
Sharp	50
Tint	00
◀ Select ▶ Adjust	

AUDIO SETTING

1. Press the MENU button twice to access the AUDIO menu on the screen. Using the CH+/CH- buttons, select an item from the options listed.
2. Use the VOL+/VOL- buttons to adjust the selected item to the proper setting.
3. The unit automatically memorizes the setting of each item.
4. The TV set will exit the Audio setting mode if no instruction is received within a 10-second period.

AUDIO	
Volume	20
Balance	00
◀ Select ▶ Adjust	

OPTION SETTING

1. Press the MENU button three times to access the OPTION menu on the screen. Using the CH+/CH- buttons, select an item from the options listed.
2. Use the VOL+/VOL- buttons to change the setting of the selected item. The TV set automatically memorizes the setting of each item.

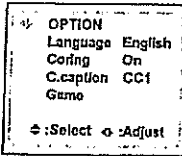

OPERATION

- This TV set offers three (3) OSD language options: English, French or Spanish.
- This TV set has the following Closed Caption options to choose from: OFF/CC1/CC2/CC3/CC4/TT1/TT2/TT3/TT4. Once the desired Closed Caption has been selected and there is no other information shown on the screen, the Closed Caption will automatically appear on the TV screen.
- From the OPTION Menu on the screen, use the CH+/CH- buttons to access the GAME sub-menu.
- The TV set will exit the OPTION setting mode if no instruction is received within a 10-second period.



GAME

After entering the OPTION menu and selecting GAME option, press VOL+ or VOL- buttons to enter the GAME sub-menu.

A three digit slot machine appears on the screen. Start the slot machine by pressing the SWAP button . Press the SWAP button  again to stop the first digit ring, a second time to stop the second digit ring and a third time to stop the third digit ring.



Prizes

If " 8 " appears in one of the digit rings you will receive 2 Gold coins.

If " 8 " appears in two of the digit rings you will receive 3 Gold coins.

If the same number appears in all three digit rings, you will receive 5 Gold coins.

If three numbers in succession appears in the digit rings (ex. 1, 2 and 3 or 3, 2 and 1), you will receive 4 Gold coins.

Press RECALL button to start the game again. Press DISP button to exit the GAME mode. When the TV set is in GAME mode, it will not shut off.

CLOCK SETTING

- Press the MENU button four times to access the CLOCK menu on the screen. Using the CH+/CH- buttons, select an item from the options listed. If clock has not been set before, all options in CLOCK menu will appear in yellow. If clock has been set, all options in CLOCK menu will appear in green (at the exception of the option that the arrow points to).
- Once the clock has been set, you can use CH+ or CH- buttons to select an option from the sub-menu on the screen. When the arrow points to an option, it means it has been selected, and it then turns to red. The other options remain displayed in green.

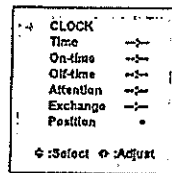

OPERATION

- Use VOL+ or VOL- button to change the setting of the options you select. Press VOL+ button to set the minutes, each press increases the minutes by one. Press VOL- button to set the hours, each press increases the hours by one. If you keep pressing the button, the minutes/hours will change more rapidly.
- The clock works on a 24 hour basis and 60 minutes per hour. When the Time display goes beyond 23 (for 11 PM), press VOL- button again will delete the Time setting. Press it once again will start the Time setting again from 00:00.
- If OFF-TIME is set, the Sleep setting will be deleted automatically. If the TV set is turned off by pressing the POWER button, the programmed OFF-TIME setting will automatically be deleted.
- Using the CH+/CH- buttons to select POSITION, press VOL+ or VOL- button to select a desired channel number. You can also use the number (0-9) buttons on the remote control to directly select a desired channel. Once POSITION setting is completed, the TV set will tune the selected channel when it automatically turns on at the programmed time (if the ON-TIME function is activated) or the tuner will automatically switch to the selected channel at the programmed time (in the EXCHANGE function is activated).

PRESET CHANNEL MENU

- Press the MENU button to enter the PRESET menu then, press CH+/CH- to select the desired option. The arrow will point to the selected option. When the TV set is in AV mode, you won't be able to enter the PRESET menu.
- Use VOL+ or VOL- button to change the setting of the options or activate the function you select.
- In PRESET menu, you can use 0-9 buttons on the remote control to select a channel number directly.
- When selected in POSITION option, the setting of the channel appears on the screen.
- Once a channel has been deleted from the preset memory, you can no longer tune it by pressing CH+/CH- buttons but need to use the number buttons on the remote control to directly select it. When such a channel is selected, its number appears in RED on the screen to indicate it is no longer programmed in the TV tuner.
- The menu will disappear from the TV screen if no instruction is received within a 10-second period.

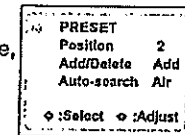

REMOTE CONTROL

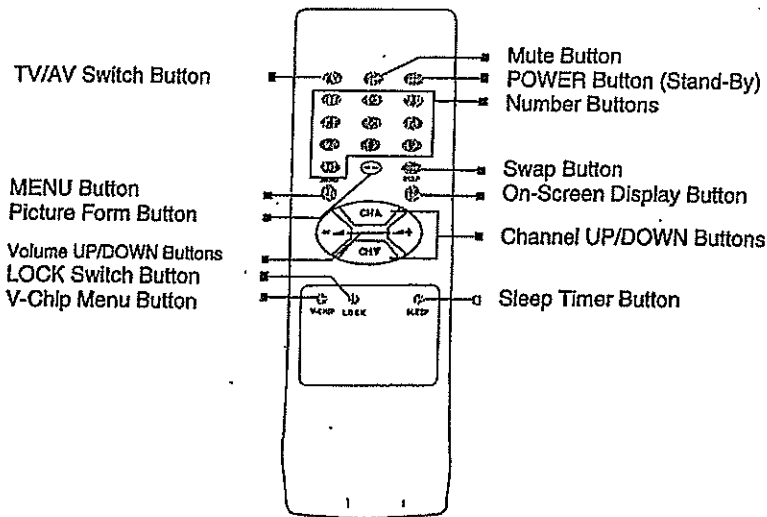

Installing the batteries

The remote control of this TV set is designed to operate with two (2) AA size batteries of 1.5 V each. To install the batteries, slide the battery compartment cover open on the back of the remote control and insert two (2) AA size batteries in the compartment observing the polarity.

Press POWER button on the remote control to turn on the TV set. Refer to diagram above for name and location of all buttons on the remote control. Refer to next page for function of each button.



Notes:

- 1) Usage of alkaline batteries strongly recommended as they last longer.
- 2) Remove exhausted batteries and replace them with new ones of similar kind when the remote control operation is erratic or unsteady.
- 3) Remove all batteries from remote control if it is not going to be used for an extended period of time.

REMOTE CONTROL

- **TV/AV button**
Press the TV/AV button, to switch source of video signal from TV program to A/V input.
- **Number buttons**
To select channel number 1 to number 9, first press 0 button, then press 1-9 button.
To select channel number 10 to number 99, directly press the two appropriate number buttons.
To select channel number 100 to number 125, press and hold 1 button until « 1 » appears on the display then press the number for the last digits.
- **Menu Button**
Press the MENU button to select, in order, the following menus; PICTURE, AUDIO, OPTION, CLOCK and PRESET.
- **Volume Down Button**
Press the VOL. - button to reduce the sound volume.
- **Channel Down Button**
Press the CH - button to tune a lower channel.
- **LOCK Switch Button**
Press the LOCK Switch, to switch between locked and unlocked TV function (the red lock will appear on the left of the screen). When locked, only POWER, LOCK SWITCH and DISP buttons function. When the TV set is in locked mode; you can also press the DISP button for four seconds to switch unit to unlock mode.
- **V-CHIP Menu Button** the V-CHIP button to enter V-CHIP menu, and go on pressing the button to select any option, or select any option by using the CH+/CH- buttons.

Press VOL+ or VOL- to change the setting or enter the next menu where the next option to set is located. Here is the TV and MPAA rating menu operation – as it appears on the screen.

- There are two categories of ratings you can block (B) or unblock (U), one based on TV programs ratings and the other one based on film ratings.
- In order to block a rating, first set the block option to ON and then enter the TV Rating or the MPAA Rating menu to program each rating level as desired.

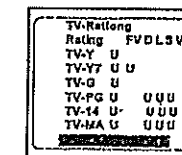
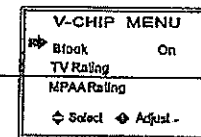

REMOTE CONTROL

- Press CH+/CH- to select any level set item, and then press MENU button to change the setting. The letter "B" on the screen indicates a blocked level and the letter "U" indicates an unblocked level. When the lowest level is set to "B", the higher levels will automatically be set to "B". When the highest level is set "U", the lower levels will be automatically be set to "U".
- Use VOL+ or VOL- button to switch between TV RATING and MPAA RATING.
- The menu will disappear from the TV screen if no instruction is received within a 10-second period.
- The level setting for TV and movie corresponds to American standards.
- MUTE Button**
Press the MUTE button to turn off the sound, press it again to turn it back on.
- Power button**
Press the POWER button to turn on the TV set, press it again to put the TV in Stand-By mode.
- Swap button**
Press the SWAP button to switch between the last channel and the current one.
- Picture Form button**
Repeated press the button, the picture will recycle as follows:

MPAA-Rating	Rating
Move	U
G	U
PG	U
PG-13	U
R	U
NC-17	U
X	U
PERSONAL	



REMOTE CONTROL

There are four preset picture quality modes for which you can choose from (Standard, Soft, Vivid and Light) plus a personal setting that allows you to adjust the picture to suit your personal taste. When selecting PERSONAL mode, you can program in memory all your preferred settings for brightness, contrast, color, etc. and the unit will automatically save them. The way to adjust settings under PERSONAL option is the same as the regular picture adjustment.

Screen display button

Press the DISP button to display on the TV screen the current channel number, color system, time and sleep off-time remain time (time needs to be set before).

Volume up button

Press the VOL + button to increase the sound volume.

Channel up button

Press the CH + button to tune a higher channel.

Sleep off-time Button

Sleep off-time can be programmed for up to 120 minutes and be set by increments of 15 minutes with each press. If you set the Sleep off-time, the TV set will cancel the setting of the Time off-time. When the Sleep off-time reaches the last minute, the information related to the Sleep off-time function will be displayed on the TV screen as a warning that the TV set is about to turn itself off.

TROUBLESHOOTING GUIDE

Should this unit exhibit a problem, check the following before seeking service:

Symptoms	Solution	Try different channel, if it is okay, it is probably a station trouble	Check aerial connections on back of set	Check aerial for broken wires	Re-orient aerial (if indoor type)	Probably local interference, such as an appliance	Adjust fine tuning control	Adjust brightness control	Adjust contrast control	Check if station is broadcasting in color	Adjust color control	Check if system switch is correct	Check if on/off switch is on	Check Batteries in Remote control
No picture, no sound		•	•	•	•	•	•	•	•	•	•	•	•	•
Poor sound, picture OK		•	•	•	•	•	•	•	•	•	•	•	•	•
Poor picture, sound OK		•	•	•	•	•	•	•	•	•	•	•	•	•
Weak picture		•	•	•	•	•	•	•	•	•	•	•	•	•
Blurred picture		•	•	•	•	•	•	•	•	•	•	•	•	•
Double image		•	•	•	•	•	•	•	•	•	•	•	•	•
Lines in picture		•	•	•	•	•	•	•	•	•	•	•	•	•
Distorted picture		•	•	•	•	•	•	•	•	•	•	•	•	•
Weak reception of some channels		•	•	•	•	•	•	•	•	•	•	•	•	•
Horizontal lines in picture		•	•	•	•	•	•	•	•	•	•	•	•	•
Picture rolls vertically		•	•	•	•	•	•	•	•	•	•	•	•	•
Poor color		•	•	•	•	•	•	•	•	•	•	•	•	•
No color in picture		•	•	•	•	•	•	•	•	•	•	•	•	•
Erratic performance from remote control		•	•	•	•	•	•	•	•	•	•	•	•	•
Remote Control does not work		•	•	•	•	•	•	•	•	•	•	•	•	•
On Screen Display control outside the screen		•	•	•	•	•	•	•	•	•	•	•	•	•

CITIZEN WARRANTY Consumer Electronics Products

Thank you for choosing Citizen!

Citizen Electronics gives the following express warranty to the original consumer purchaser or gift recipient for this Citizen brand product, when shipped in its original container and sold or distributed in Canada by Citizen Electronics or by an Authorized Citizen Dealer:

Citizen Electronics warrants that this product is free, under normal use and maintenance, from any defects in material and workmanship. If any such defects should be found in this product within the applicable warranty period, Citizen Electronics shall, at its option, repair or replace the product as specified herein. Replacement parts furnished in connection with this warranty shall be warranted for a period equal to the unexpired portion of the original equipment warranty.

This warranty shall not apply to:

- a. Any defects caused or repairs required as a result of abusive operation, negligence, accident, improper installation or inappropriate use as outlined in the owner's manual.
- b. Any Citizen product tampered with, modified, adjusted or repaired by any party other than Citizen Electronics or Citizen's Authorized Service Centres.
- c. Damage caused or repairs required as a result of the use with items not specified or approved by Citizen Electronics, including but not limited to head cleaning tapes and chemical cleaning agents.
- d. Any replacement of accessories, glassware, consumable or peripheral items required through normal use of the product including but not limited to earphones, remote controls, AC adapters, batteries, temperature probe, stylus, trays, filters, cables and paper.
- e. Any cosmetic damage to the surface or exterior that has been defaced or caused by normal wear and tear.
- f. Any damage caused by external or environmental conditions, including but not limited to transmission line/power line voltage or liquid spillage.
- g. Any product received without appropriate model, serial number and CSA/CUL markings.
- h. Any products used for rental or commercial purposes.
- i. Any installation, setup and/or programming charges.

Should this Citizen product fail to operate during the warranty period, warranty service may be obtained upon delivery of the Citizen product together with proof of purchase and a copy of this LIMITED WARRANTY statement to an Authorized Citizen Service Centre. In-home warranty service may be provided at Citizen Electronics' discretion on any Citizen television with the screen size of 27" or larger. This warranty constitutes the entire express warranty granted by Citizen Electronics and no other dealer, service centre or their agent or employee is authorized to extend, enlarge or transfer this warranty on behalf of Citizen Electronics. To the extent the law permits, Citizen Electronics disclaims any and all liability for direct or indirect damages or losses or for any incidental, special or consequential damages or loss of profits resulting from a defect in material or workmanship relating to the product, including damages for the loss of time or use of this Citizen product or the loss of information. The purchaser will be responsible for any removal, reinstallation, transportation and insurance costs incurred. Correction of defects, in the manner and period of time described herein, constitute complete fulfillment of all obligations and responsibilities of Citizen Electronics to the purchaser with respect to the product and shall constitute full satisfaction of all claims, whether based on contract, negligence, strict liability or otherwise.

WARRANTY PERIODS: Parts & Labour (exceptions noted)

- Audio Products 1 year (Remote Control, if applicable – 90 Days)
- DVD Products 1 year (Remote Control – 90 Days)
- LCD & Plasma Display TV 1 year (Remote Control – 90 Days)
- Microwave Ovens 1 Year
- Television Products 1 Year (Remote Control – 90 Days)
- VCR Products 1 Year (Remote Control – 90 Days, video heads – 6 Months)

To obtain the name and address of the nearest Authorized Citizen Service Centre or Dealer, please contact: Citizen Electronics, 455 Gordon Baker Road, Toronto, Ontario M2H 4H2 or visit our web site: www.citizen-electronics.com

For more information on this Warranty or Service Locations, please call (416) 499-5611 or toll free 1-800-663-5954, Monday to Friday 9:00am – 5:00pm Eastern Standard Time.